

# Meridian Digital Telephones

M3902  
M3903  
M3904

Quick Reference Guide





<b>M3902, M3903, and M3904 Meridian Digital Telephones</b>	<b>1</b>
<b>Your Telephone Call Features</b>	<b>3</b>
Use Auto Dial .....	3
Make a Call .....	4
Make a call while on-hook .....	5
Redial last number called .....	5
Use Ring Again (M3902) .....	6
Use Ring Again (M3903 and M3904) .....	7
Use Hot Line .....	8
Use Speed Call (M3902) .....	8
Use Speed Call (M3903 and M3904) .....	9
<b>Answer a call</b>	<b>11</b>
Place a call on Hold .....	11
Transfer a call (M3902) .....	12
Transfer a call (M3903 and M3904) .....	13
<b>Handle multiple calls</b>	<b>14</b>
Use Call Waiting .....	14
Forward calls (M3902) .....	15
Forward calls (M3903 and M3904) .....	16
<b>Additional call features</b>	<b>17</b>
Use Call Pickup .....	17
Set up a Conference call (M3902) .....	18
Set up a Conference call (M3903 and M3904) .....	18
Join a call .....	19
Engage Group Listening .....	20
Use the Voice Messaging control screens (M3903 and M3904) .....	20
<b>Options List</b>	<b>22</b>
Select a language .....	23
Change a Feature Key label (M3902) .....	23
Change a Feature Key label (M3903 and M3904) .....	25
Adjust Screen contrast .....	27

Adjust volume .....	27
Choose Ring type .....	28
Select Call Log options .....	28
Use Live dial pad .....	29
Select Preferred name match .....	29
Set up area code .....	29
Enable Call timer .....	30
Select Date/time format .....	30
Enable Key click .....	30
Use Headset port on call .....	31
Activate Headset port external alerter .....	31
Use Call indicator light .....	31
Set On hook default path .....	32
Display diagnostics .....	33
Activate Group Listening .....	33

## **Call Log/Personal Directory display and controls** **34**

---

Identify specialized keys .....	34
Use Directory password protection .....	35

## **Manage Call Log** **37**

---

Access and use the Callers List (M3903) .....	37
Access and use the Callers List (M3904) .....	38
Access and use the Redial List (M3903) .....	40
Access and use the Redial List (M3904) .....	41

## **Access and use the Personal Directory** **42**

---

Access the Personal Directory .....	42
Add a Personal Directory entry .....	42
Add an incoming call .....	44
Delete or edit a Personal Directory entry .....	45
Delete your Personal Directory .....	46
Use the Personal Directory to make a call .....	46
Use Card View .....	47
Search for an entry .....	48
Copy a number from the Redial List .....	48

<b>Set-to-Set Messaging</b>	<b>50</b>
<b>Corporate Directory</b>	<b>53</b>
<b>Virtual Office</b>	<b>56</b>
<b>Secure your telephone</b>	<b>58</b>



## M3902, M3903, and M3904 Meridian Digital Telephones

There are five models in the M3900 Series Meridian Digital Telephone portfolio. This document describes the **M3902**, **M3903**, and **M3904** features and how to use them. For user information on the M3901, refer to the *M3900 Series Meridian Digital Telephone User Guide*. For information on the M3905, refer to the *M3905 Call Center Meridian Digital Telephone User Guide*.

The **M3902** has one Line (DN) Key and three Programmable Feature Keys (self-labeled).

### M3902 telephone

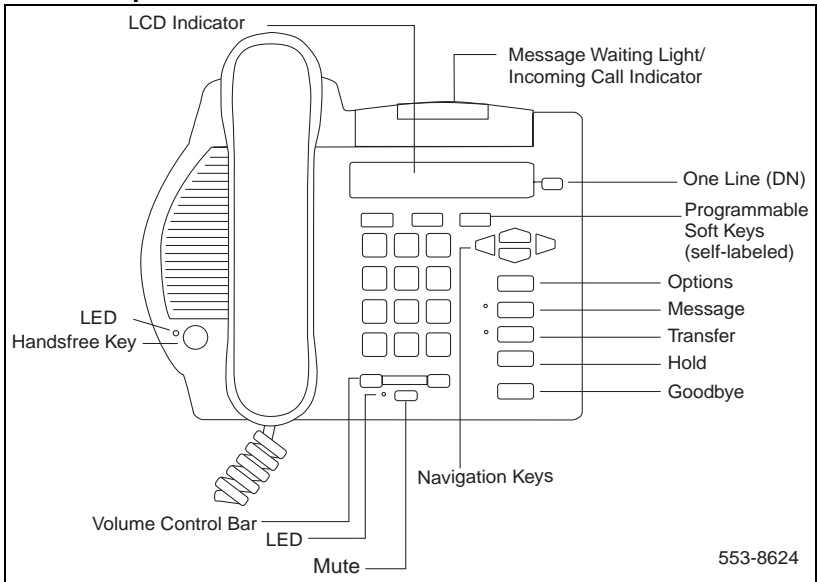

The **M3903** has two Programmable Line (DN)/Feature Keys (self-labeled) with two features or lines (DNs) configured on each key. The **M3903** also has four Context Sensitive Soft Keys (self-labeled).

**M3903 telephone**

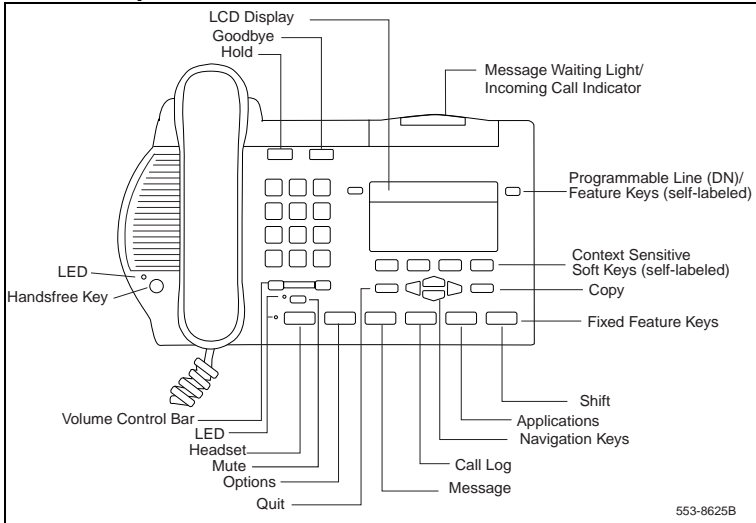

The **M3904** has six Programmable Line (DN)/Feature Keys (self-labeled), with two features or lines (DNs) configured on each key. The **M3904** also has four Context Sensitive Soft Keys (self-labeled).

**M3904 telephone**

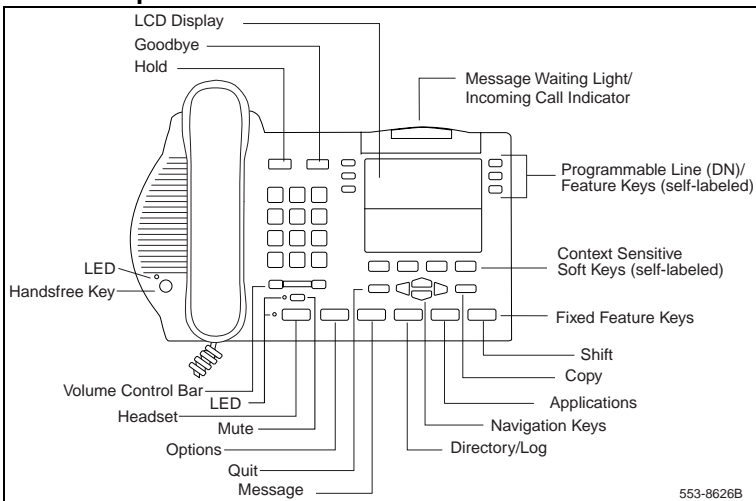



## Your Telephone Call Features

Your M3900 Series Meridian Digital Telephone provides easy access to a wide range of business features. Your network administrator assigns features to your telephone and provides you with passwords and other codes as required.

This section describes the features available for your telephone and how to use them.

### Use Auto Dial

---

The **Auto Dial** feature allows the user to press one Feature Key (Auto Dial Key) to dial a specific telephone number automatically. This feature must be enabled by your network administrator.

#### To use Auto Dial:



AutoDial



1. Lift the **handset**.
2. Press the associated **Auto Dial** Key.  
This automatically dials the number.

#### To display the Auto Dial number (M3903 and M3904):

Display



AutoDial



1. Press the **Display** Key.  
**Note:** On the Meridian SL-100, press the **Auto Dial** Key to display the number.
2. Press the configured **Auto Dial** Key.  
The number appears on the display.

#### To store an Auto Dial number:

AutoDial



1. Press the **Auto Dial** Key, without lifting the handset.
2. **Dial** the number to be stored on the Auto Dial Key.

**Note 1:** The number may contain up to 31 digits.

**Note 2:** If you are storing an external or long distance number, be sure that the appropriate access codes are included.

AutoDial



3. Press the **Auto Dial** Key again.  
The number is stored on the key.

**Note:** To change the key label “AutoDial”, select **Change feature key label** from the **Options List** menu. Please see “Change a Feature Key label (M3902)” on page 23 for detailed instructions.

## Make a Call

---

To make a call from your telephone, use the following procedure:



or

2637



or



or



1. Lift the **handset**.

or

Press the **Line** (DN) Key.

or

Press the **Handsfree** Key.

**Note:** The Handsfree Key must be enabled by the network administrator

or

Press the **Headset** Key if you have a headset connected to your telephone’s headset jack (available on the **M3903** and **M3904**). The LED next to the key lights steadily to indicate that you are in headset mode.

**Note:** See “Set On hook default path” on page 32 for information on headsets and how to configure your telephone for use with a headset.

2. **Dial** the number.

**Note:** Whenever you see the message “Lift the **handset**.” in this guide, you may alternatively press a free Line (DN) Key, the Handsfree Key, or Headset Key (if a headset is connected to the headset jack). You receive a dial tone from each action.

## Make a call while on-hook

Leave the handset in the cradle while you dial a number.

To dial on-hook:

2637



1. Press a **Line (DN)** Key.
2. **Dial** the number when you receive a dial tone.
3. Lift the **handset** to speak when the called party answers.

If the called number is busy:



or

RingAgain



Press the **Goodbye** Key to release the line.

or

Press the **Ring Again** Key.

## Redial last number called

The **Last Number Redial** feature allows you to automatically redial the last number you dialed. This feature must be enabled by your network administrator.

To use **Last Number Redial**:



2637



1. Lift the **handset**.
2. Press a **Line (DN)** Key.

To use **Last Number Redial** on a handsfree call:

2637



2637



Press the **Line (DN)** Key twice.

The last number you dialed is automatically redialed.

**Note:** On Meridian SL-100, press the **#** Key twice.

### Use Ring Again (M3902)

---

Use the **Ring Again** feature when you dial a number and receive a busy tone or no answer. The Ring Again feature lets you know when the person you dialed is available or has used their telephone. The feature notifies you when to redial your party. The Ring Again feature automatically redials the number.

To use Ring Again:



RingAgain



To call a Ring Again party when you receive notification:



RingAgain



To cancel Ring Again before notification:

RingAgain



1. **Dial** a number and receive a busy tone or no answer.

**Note:** On the Meridian SL-100, Ring Again is available on busy tone only.

2. Press the **Ring Again** Key.

When the number you want to reach is available, or the person has re-used their set, you hear the Ring Again tone.

1. Lift the **handset**.
2. Press the **Ring Again** Key.

Press the **Ring Again** Key a second time.

## Use Ring Again (M3903 and M3904)

Use the **Ring Again** feature when you dial a number and receive a busy tone or no answer. The Ring Again feature lets you know when the person you dialed is available or has used their telephone. The feature notifies you when to redial your party. The Ring Again feature automatically redials the number.

To use Ring Again:



RingAgain



To call a Ring Again party when you receive notification:



RngCall



To cancel Ring Again before notification:

CancelRA



1. **Dial** a number and receive a busy tone or no answer.

**Note:** On the Meridian SL-100, Ring Again is available on busy tone only.

2. Press the **Ring Again** Key.

The screen displays Ring again is active.

When the number you want to reach is available, or the person has re-used their set, you hear the Ring Again tone and the screen displays Party free, select line.

1. Lift the **handset** or press a Line (DN) Key.
2. Press the **Ring Call** Key.

Press the **Cancel Ring Again** Key. The screen displays Ring Again is cancelled.

### Use Hot Line

---

The network administrator can program a **Hot Line** Key that allows you to dial a specific number automatically. The network administrator can apply other features to the Hot Line, such as Call Redirection, so that the Hot Line call is answered by a person—not a mail box.

**To use Hot Line:**

Hotline



Press the **Hot Line** Key.

The Hot Line Key automatically dials the number.

**Note 1:** If your main Line (DN) is a Hot Line, lift the handset. The Hot Line Key dials the number automatically.

**Note 2:** On the Meridian SL-100, the Automatic Line (AUL) feature is the same as the Hot Line feature.

### Use Speed Call (M3902)

---

The **Speed Call** feature allows you to automatically dial frequently called numbers by entering a one, two, or three digit code. Contact your network administrator to determine the capacity of your Speed Call list.

A telephone designated as a Speed Call Controller can program or edit the Speed Call list. This feature must be enabled by your network administrator.

**To store or change a Speed Call number:**

SPcCt.ln



1. Press the **Speed Call Controller** Key. The triangular icon flashes, which indicates it is in programming mode.
2. **Dial** a one, two, or three digit code and associated telephone number when the phone prompts.

**Note 1:** Dial the access code (if required) followed by the internal, external, or long-distance telephone number.

**Note 2:** Press the **Pause** Key to insert a 1.5 second pause in the dialing string.

SpcCtrl



To make a Speed Call:



SpcCtrl



or

SpcUsr



3. Press the **Speed Call Controller** Key again to save the code and number.  
The flashing icon turns off.

1. Lift the **handset**.
2. Press the **Speed Call Controller** Key or the **Speed Call User** Key.
3. **Dial** the Speed Call code assigned to the telephone number.

## Use Speed Call (M3903 and M3904)

The **Speed Call** feature allows you to automatically dial frequently called numbers by entering a one, two, or three digit code. Contact your network administrator to determine the capacity of your Speed Call list.

A telephone designated as a Speed Call Controller can program or edit the Speed Call list. This feature must be enabled by your network administrator.

To store or change a Speed Call number:

SpcCtrl



1. Press the **Speed Call Controller** Key.  
The screen displays Enter Code, then number.
2. **Dial** a one, two, or three digit code. Use the **Delete** Key if you make a mistake. Use the **Cancel** Key to leave the screen without storing a speed call number.

**Note:** A dash is automatically inserted after the required number of digits have been entered.

3. **Dial** the associated telephone number. Use the **Delete** Key if you make a mistake. Use the **Cancel** Key to leave the screen without storing a speed call number.

Done



## To make a Speed Call:



SpcCtrl



or

SpcUsr



**Note 1:** Dial the access code (if required) followed by the internal, external, or long-distance telephone number.

**Note 2:** Press the **Pause** Key to insert a 1.5 second pause in the dialing string.

4. Press the **Done** Key to save the code and number.

1. Lift the **handset**.

2. Press the **Speed Call Controller** Key or the **Speed Call User** Key.

The screen displays Enter code.

3. **Dial** the Speed Call code assigned to the telephone number.



## Answer a call

When you receive an incoming call, your telephone rings and the LCD indicator  flashes.

To answer a call:

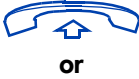

or



or



Lift the **handset**.

or

Press the **Handsfree** Key.

or

Press the flashing **Line** (DN) Key when using a headset.

## Place a call on Hold

Use the **Hold** feature when you are talking with one party and a second call comes in on a second line. You can answer the second call and retain the original call by putting it on hold.

To place a call on hold:



Press the **Hold** Key.

The LCD indicator flashes beside the line on hold.

**Note 1:** If Automatic Hold feature is configured for your Meridian 1, the active call is automatically put on hold when you answer the second call.

**Note 2:** On the Meridian SL-100, Automatic Hold is the default feature.

**Note 3:** The caller hears music while on hold if the Music On Hold feature is configured for your system.

To retrieve a call on hold:



Press the **Line** (DN) Key beside the flashing LCD indicator.

## Transfer a call (M3902)

---

Use the **Transfer** feature to direct a call to a third party.



1. Press the **Transfer** Key.

The other party is on hold and you receive dial tone. The LCD indicator lights steadily.

2. **Dial** the number of the telephone where the call is to be transferred.

3. When you hear the ring or a person answers, press the **Transfer** Key to complete the call transfer.

The LED indicator goes from steady on to off.

**To go back to the original call if the transfer is incomplete:**



If the person you called is not available, press the **Line** (DN) Key to reconnect to the original call.

The LCD indicator goes from flashing to steady on.

**Note:** On the Meridian SL-100, press the **Transfer** Key, dial the number, and press the **Goodbye** Key. If you press the **Transfer** Key a second time, you get a three-way conference.

## Transfer a call (M3903 and M3904)

Use the **Transfer** feature to direct a call to a third party.

To use the **Transfer** feature:

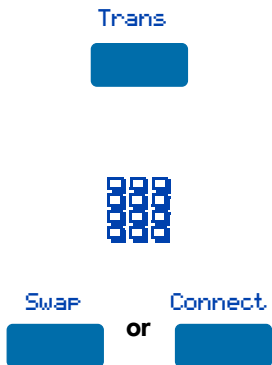

1. Press the **Transfer** Key.  
The other party is on hold and you receive dial tone. The screen displays **Call on hold, dial number**.
2. **Dial** the number of the telephone where the call is to be transferred.
3. Press the **Swap** Key to switch between talking with the original caller and the new caller. Press the **Connect** Key to complete the transfer.

The two callers are connected and your telephone is ready to make or receive new calls.

To go back to the original call if the transfer is incomplete:

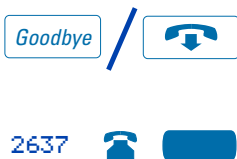

1. Press the **Goodbye** Key.
2. Press the **Line** (DN) Key with the flashing icon to return to your original call.

## Handle multiple calls

### Use Call Waiting

The **Call Waiting** feature allows you to put your current call on hold while you answer an incoming call. This feature must be enabled by your network administrator.

**To answer an incoming call while on another call:**



1. Press the **Hold** Key when you hear the tone.

The Call Waiting status icon appears in the display.



2. Press the **Call Wait** Key (**CWait** for **M3902**) to answer the call.

**To return to your first telephone call:**



1. Press the **Hold** Key, if you want to put the second call on hold.

or

or



Press the **Goodbye** Key to end the second call.



2. Press the **Line** (DN) Key associated with the first call.

**If you do not have a Call Waiting Key:**



1. If you do not have a Call Waiting Key and you hear the Call Waiting tone, press the **Goodbye** Key to end your current call.



2. Press the **Line** (DN) Key beside the flashing status icon to answer the incoming call.

## Forward calls (M3902)

The **Call Forward** feature allows you to direct your calls to ring at another Line (DN). If the telephone begins to ring, you cannot forward an incoming call in progress.

To forward your calls:

Forward



Forward



1. Press the **Forward** Key, or lift the handset and enter the Call Forward All Calls Activate FFC (Meridian 1) or FAC (Meridian SL-100).
2. **Dial** the DN where you want to forward your calls.
3. Press the **Forward** Key.

To view the number that your calls are being forwarded to:

Display



Forward



1. Press the **Display** Key (Meridian 1) or **Inspect** Key (Meridian SL-100), or lift the handset and enter the Call Forward All Calls Verify FFC.
2. Press the **Forward** Key.

This action displays the forward number and leaves Call Forward active.

To cancel Call Forward:

Forward



Press the **Forward** Key, or lift the handset and enter the Call Forward All Calls Deactivate FFC (Meridian 1) or FAC (Meridian SL-100).

To reinstate Call Forward to the same number:

Forward



Forward



Press the **Forward** Key twice.

### Forward calls (M3903 and M3904)

---

The **Call Forward** feature allows you to direct your calls to ring at another line (DN). If the telephone begins to ring, you cannot forward an incoming call in progress.

To forward your calls:

Forward



Done



To view the number that your calls are being forwarded to:

CheckFw



Exit



To cancel Call Forward:

CheckFw



Canc1Fw



1. Press the **Forward** Key.  
The previously stored forward number appears, if one exists, and the screen displays Enter forward number.
2. If desired, enter a new number. The existing number is automatically deleted. If you make a mistake, use the **Delete** Key to delete the previous digit(s). Press **Cancel** to leave this screen without forwarding your telephone or changing the number.
3. Press the **Done** Key to activate Call Forward.

1. Press the **Check Forward** Key.
2. Press the **Exit** Key to return to the previous screen.  
This action will leave Call Forward active.

1. Press the **Check Forward** Key.
2. Press the **Cancel Forward** Key.

## Additional call features

### Use Call Pickup

**Call Pickup** allows you to pick up a call from any telephone in the same Pickup Group or another Pickup Group. This feature must be enabled by, and Pickup Group numbers must be assigned by, your network administrator.

**To answer a call in your own Call Pickup Group:**



Pickup



1. Lift the **handset**.
2. Press the **Pickup** Key, or enter the Pickup Ringing Number FFC (Meridian 1) or FAC (Meridian SL-100).

**To answer an incoming call in another Call Pickup Group:**



GrpPickup



1. Lift the **handset**.
2. Press the **Group Pickup** Key, or enter the Pickup Group FFC.
3. **Dial** the Pickup Group number of the telephone that is ringing.

**Note:** This feature is not available on the Meridian SL-100.

**To answer a call at a specific extension number within your Pickup Group:**



DNPickup



1. Lift the **handset**.
2. Press the **DN Pickup** Key, or enter the Pickup Directory Number FFC (Meridian 1) or the Directed Call Pickup FAC (Meridian SL-100).
3. On the Meridian SL-100 dial the DN of the ringing number.

**Note:** If the pickup DN is invalid, you receive an overflow burst tone, and the screen displays *Release and try again*. Press the **Goodbye** Key.

## Set up a Conference call (M3902)

---

You can set up a **Conference** call for up to six people (including yourself). Contact your network administrator to determine the maximum number of people your system allows on a conference call.

To set up a conference call:



1. Press the **Conference** Key while you are on a call.

The other party is on hold and you receive a dial tone.



2. **Dial** the number of the person you want to add to the conference.



3. Press the **Conference** Key when the person answers.

Everyone is able to join the conversation.

If the person you attempt to add to the conference is unavailable:



1. Press the **Goodbye** Key.



2. Press the **Line** (DN) Key to return to your original call.

## Set up a Conference call (M3903 and M3904)

---

You can set up a **Conference** call for up to six people (including yourself). Contact your network administrator to determine the maximum number of people your system allows on a conference call.

To set up a conference call:



1. Press the **Conference** Key while you are on a call.

The other party is on hold and you receive a dial tone. The screen displays Call on hold, dial number.





If the person you attempt to add to the conference is unavailable:

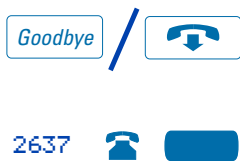

2. **Dial** the number of the person you want to add to the conference.
3. Press the **Swap** Key to switch between talking with the original caller and the new caller. Press the **Connect** Key to complete the conference.  
Everyone is able to join the conversation.

1. Press the **Goodbye** Key.
2. Press the **Line** (DN) Key with the flashing icon to return to your original call.

## Join a call

The **Call Join** feature allows you to connect an incoming call to a call already in progress thereby creating a conference call. In order to use Call Join, your telephone must be configured with either a second line (DN) or a Call Waiting Key.

To connect a call on hold (on a different line) to your current call:

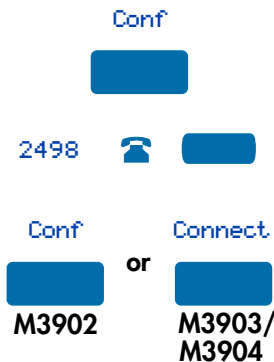

1. Press the **Conference** Key.
2. Press the **Key** that has the caller you want to connect to your current call.
3. Press the **Conference** Key again (M3902), or press the **Connect** Key (M3903 and M3904).

The person on hold joins your conversation.

## Engage Group Listening

---

The **Group Listening** feature allows others to listen to a call through the speaker while you are speaking through the handset. Group Listening must be enabled by your network administrator. Please refer to “Activate Group Listening” on page 33 for instructions on activating the **Group Listening** option in the **Options List**.

**To engage Group Listening while on a call:**



Press the **Handsfree** Key. Everyone hears the caller over the speaker, but the caller only hears what is picked up by the handset.

**Note:** You must let the caller know when others are listening to the conversation. This feature does not provide a tone to inform the party on the other end of the call that the conversation is being monitored.

## Use the Voice Messaging control screens (M3903 and M3904)

---

The **Voice Messaging** control screens allow you to send commands while connected to your voice messaging system using the Soft Keys instead of the dial pad. **Note:** This feature is not available on the Meridian SL-100.

**To use Voice Messaging controls:**

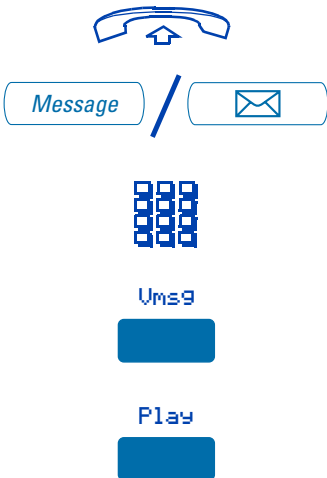

1. Lift the **handset**.
2. Press the **Message** Key.
3. Use the **dial pad** to log in to your voice mailbox.
4. Press the **Voice Message** Key.
5. Press the **Play** Key to play your first new message.

**Note:** Use the **More. . .** Key to view

Stop



or

Last



or

Next



or

Delete



or

Skip→



or

Skip←



Quit



additional message options.

6. Press the **Stop** Key to pause playback of the message. Press **Play** to resume playback

or

Press the **Last** Key to go to the previous message. Press **Play** to playback the message or Press **Last** again to move to previous messages.

or

Press the **Next** Key to go to the next message. Press **Play** to playback the message or Press **Next** again to move to later messages.

or

Press the **Delete** Key to delete the current message.

or

Press the **Skip Forward** Key to advance three seconds in the current message.

or

Press the **Skip Backward** Key to rewind three seconds in the current message.

7. Press the **Quit** Key at any time to exit your voice messaging system. Your telephone is now ready to make or receive new calls.

## Options List

The **Options List** allows you to customize certain characteristics of your phone. Screen prompts take you step-by-step through procedures and keep you informed on the status of the following settings: Language, Change feature key label, Screen contrast, Volume adjustment, Ring type, Call log options, Live dial pad, Preferred name match, Area code set-up, Call timer enable, Date/time format, Key click enable, Headset port on call, Headset port external alerter and recorder interface, Call indicator light, On hook default path, and Display diagnostics.

**To change any option's setting:**



Select



Done



Quit

or



1. Press the **Options** Key.
2. Use the **Navigation** Keys to move up or down through the options list.
3. Press the **Select** Key when the desired option is highlighted.
4. Change the option's settings. Refer to the following pages for details. The display also provides you with information to adjust your selection.
5. Press the **Done** Key to save your changes.
6. Press the **Quit** Key or **Options** Key to exit.

**Note:** If you press the **Quit** Key or **Options** Key before you press the **Done** Key, you exit the Options List without saving your changes.

## Select a language

The display is available in multiple languages. After you select **Language . . .** from the **Options List** menu,



Deutsch

Select



1. Use the **Navigation** Keys to highlight the desired language (e.g., German).

2. Press the **Select** Key.

Press the **Done** Key to save changes. Press the **Quit** Key or **Options** Key to exit.

## Change a Feature Key label (M3902)

You can change the labels on the three feature keys located at the bottom of the display on the **M3902**.

To change a Feature Key label:



Change feature key label

Select



Select



1. Use the down **Navigation** Key to highlight Change feature key label.

2. Press the **Select** Key.

This action takes you to the **Feature Key** menu and highlights Edit a feature key label.

3. Press the **Select** Key again.

The prompt asks you to select the key you want to change.

4. Use the **Navigation** Keys to highlight the label you want to change, (e.g., **AutoD1**).

Select



5. Press the **Select** Key.
6. Press the **Dial Pad** Key that is printed with the first letter in your new label. Press the key until the correct character appears.
7. Repeat step 6 until you have changed the entire label.

Press the **Done** Key to save changes. Press the **Quit** Key or **Options** Key to exit.

**Note 1:** For a detailed example of using the dial pad to enter text into your M3900 Series telephone, please see "Add a Personal Directory entry" on page 42.

**Note 2:** You cannot change the label on your primary DN.

**Note 3:** Use the **Case** Key to change the case of the letter, as needed. You can use the **Delete** Key to delete one character, or the **Clear** Key if you want to delete the entire label.

**Note 4:** Press the **Up Navigation** Key to access special characters you may want to include in the label. Use the **Navigation** Keys to locate the character you want to include. Press the **Select** Key to choose the highlighted character. Press the **Return** Key to return to label entry without selecting a special character.

To restore all key labels:



Restore all key labels

Select



Restore



1. Use the down **Navigation** Key to highlight **Restore all key labels**.
2. Press the **Select** Key.  
The display asks you to verify that you want to restore all labels.
3. Press the **Restore** Key.

Press the **Done** Key to return to the **Options List**. Press the **Options** Key to exit.

## Change a Feature Key label (M3903 and M3904)

You can change the name on the Programmable Line (DN)/Feature Keys (self-labeled). These keys are located on both sides of the top portion of the display area on the **M3903** and **M3904**.

To change a Feature Key label:



Change feature key label

Select



Select



AutoDial



1. Use the down **Navigation** Key to highlight Change feature key label.

2. Press the **Select** Key.

This action takes you to the **Feature Key** menu and highlights Change feature key label.

3. Press the **Select** Key again.

The prompt asks you to select the key you want to change.

4. Press the **Programmable Line (DN)/Feature** Key whose label you want to change, (e.g., **AutoDial**).

5. Press the **Dial Pad** Key that is printed with the first letter in your new label. Press the key until the correct character appears.

6. Repeat step 5 until you have changed the entire label.

Press the **Done** Key to save changes. Press the **Quit** Key or **Options** Key to exit.

**Note 1:** For a detailed example of using the dial pad to enter text into your M3900 Series telephone, please see “Add a Personal Directory entry” on page 42.

**Note 2:** You cannot change the label on the primary DN. Press the **Shift** Key if the label you want to change is on the second layer of the **Programmable Line (DN)/Feature** Keys (self-labeled).

**Note 3:** Use the **Case** Key to change the case of the letter, as needed. You can use the **Delete** Key to delete one character, or the **Clear** Key (**M3903**) if you want to delete the entire label. On the **M3903** you may use the **Space** Key to enter a space or the **Restore** Key to restore the label to the default value.

**Note 4:** Press the **Up Navigation** Key or the **Chars** Key (**M3903**) to access special characters you may want to include in the label. Use the **Navigation** Keys to locate the character you want to include. Press the **Select** Key to choose the highlighted character. Press the **Return** Key to return to label entry without selecting a special character.

### To restore one key label (M3904):



Restore one key label

Select



Purchasing



1. From the **Feature Key** menu, use the down **Navigation** Key to highlight Restore one key label.
2. Press the **Select** Key.
3. Press the **Programmable Line (DN)/Feature** Key (self-labeled) that you want to restore to the original label (e.g., Purchasing).

Press the **Done** Key to return to the **Options List** menu. Press the **Quit** Key or **Options** Key to exit.

### To restore all key labels:



Restore all key labels

Select



Restore



1. Use the down **Navigation** Key to highlight Restore all key labels.
2. Press the **Select** Key.  
The display asks you to verify that you want to restore all labels.
3. Press the **Restore** Key.

Press the **Done** Key to return to the **Options List**. Press the **Options** Key to exit.



## Adjust Screen contrast

The **Screen contrast** option allows you to adjust the contrast of the display on your telephone. After you select Screen contrast from the **Options List** menu;



From the **Contrast** screen, press the **Lower** Key to decrease the display contrast level, or press the **Higher** Key to increase the display contrast level.

Press the **Done** Key to save changes. Press the **Quit** Key or **Options** Key to exit.

## Adjust volume

**Note:** After you select Volume adjustment... from the **Options List** menu, a list of adjustable items for your telephone model appears. It is recommended that you adjust these parameters while you are on a telephone call so that you can judge the impact of the changes you are making.

**To adjust the Ringer volume:**

Ringer



1. Select **Ringer** from the **Volume** menu.
2. Press the **Lower** Key to decrease the ringer volume, or press the **Higher** Key to increase the ringer volume.

Press the **Done** Key to save changes. Press the **Quit** Key or **Options** Key to exit.

Use the procedure above to adjust the volume on the following items:

Buzzer

Headset listen

Speaker

Headset talk

Handset listen

Headset sidetone

Handsfree listen

**Note 1:** Headset listen is adjustable on the **M3903** and **M3904** only.

**Note 2:** Headset talk and Headset sidetone are adjustable on the **M3904** only.

**Note 3:** Headset sidetone (**M3904** only) is the sound of your own voice that you hear in the headset speaker.

## Choose Ring type

The **Ring type** option allows you to choose from among the various ringing sounds available for your telephone model. After you select **RING TYPE...** from the **Options List** menu;



Ring type 3

Play



Select



1. Use the **Navigation** Keys to scroll through the list of ring types.
2. Press the **Play** Key to sample a ring tone.
3. Press the **Select** Key to activate the desired ring type (**M3903** and **M3904**).

Press the **Done** Key to save changes. Press the **Quit** Key or **Options** Key to exit.

## Select Call Log options

The **Call Log options** (available on the **M3903** and **M3904**) provides a choice of logging all incoming calls, logging only the unanswered calls, or not logging any calls. The Call Log holds up to 10 different incoming entries for the **M3903** and up to 20 for the **M3904**. After you select **Call log options** from the **Options List** menu;



Log all calls

or

Log unanswered calls

From the **Log options** menu, use the **Navigation** Keys to highlight and select either:

Log all calls

or

Log unanswered calls

**Note:** New call indication must be set to **On**, if you want Call Log notification.

Press the **Done** Key to save selection. Press the **Quit** Key or **Options** Key to exit.

## Use Live dial pad

---

The **Live dial pad** option (available on the **M3904**) allows you to press any dial pad key to automatically access a dial tone. After you select Live dial pad from the **Options List** menu;

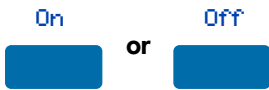

From the **Live dialpad** screen, press the **On** Key to turn on Live dial pad, or press the **Off** Key to turn off Live dial pad.

Press the **Done** Key to save changes. Press the **Quit** Key or **Options** Key to exit.

## Select Preferred name match

---

The **Preferred name match** option (available on the **M3904**) displays the names of incoming and outgoing callers as stored in your Personal Directory, if the telephone number matches the one stored in your directory. This option allows you to personalize the displayed names for incoming and outgoing calls. After you select Preferred name match from the **Options List** menu;



From the **Name match** screen, press the **On** Key to turn on Preferred name match, or press the **Off** Key to turn off Preferred name match.

Press the **Done** Key to save changes. Press the **Quit** Key or **Options** Key to exit.

## Set up area code

---

Using the **Area code set-up** option (available on the **M3904**) causes the Callers List and Calling Line ID (CLID) display show the number/extension followed by the area code/prefix in parenthesis. This makes it easier to identify local calls and internal calls. You can define up to three area codes. After you select Area code set-up from the **Options List** menu

**1st Code: 408**  
**2nd Code:**  
**3rd Code:**

Use the **Navigation** keys to place your cursor in the first line and use the dial pad to enter an area/country code of your choice.

**Note:** You can enter up to three codes of your choice.

Press the **Done** Key to save changes. Press the **Quit** Key or **Options** Key to exit.

### Enable Call timer

---

The **Call timer enable** option measures how long you are on each call. After you select **Call timer enable** from the **Options List** menu;



From the **Call timer** screen, press the **On** Key to turn on the Call timer, or press the **Off** Key to turn off the Call timer.

Press the **Done** Key to save changes. Press the **Quit** Key or **Options** Key to exit.

### Select Date/time format

---

There are eight **Date/time formats**. Four formats are based on the 12 hour clock and four are based on the 24 hour clock. After you select **Date/time format...** from the **Options List** menu;



Use the **Navigation** Keys to scroll through the eight formats.

Format 3

Press the **Done** Key to select the highlighted format. Press the **Quit** Key or **Options** Key to exit.

### Enable Key click

---

The **Key click** option causes the handset or speaker to produce a clicking sound when you press the telephone keys. After you select **Key click enable** from the **Options List** menu;



From the **Key click** screen, press the **On** Key to turn on Key click, or press the **Off** Key to turn off Key click.

Press the **Done** Key to save changes. Press the **Quit** Key or **Options** Key to exit.

## Use Headset port on call

---

The **Headset port on call** option (available on the **M3904**) requires that a lamp-type accessory be connected to the headset port. When the Headset port on call option is activated and the user is on a call, the lamp lights providing an indication that a call is in progress. After you select **Headset port on call** from the **Options List** menu;



From the **On call** screen, press the **On** Key to turn on Headset port on call, or press the **Off** Key to turn off Headset port on call.

Press the **Done** Key to save changes. Press the **Quit** Key or **Options** Key to exit.

**Note:** Additional equipment is required to implement this option. For more information please contact your Nortel Networks distributor.

## Activate Headset port external alerter

---

When the **Headset port external alerter** option (available on the **M3904**) is activated, it supports a visual or audible alerter and/or recorder device. This device plugs into the Headset port, which is located on the bottom of the telephone. After you select **Headset port ext. alerter** from the **Options List** menu;



From the **External alerter** screen, press the **On** Key to turn on Headset port external alerter, or press the **Off** Key to turn off Headset port external alerter.

Press the **Done** Key to save changes. Press the **Quit** Key or **Options** Key to exit.

**Note:** Additional equipment is required to implement this option. For more information please contact your Nortel Networks distributor.

## Use Call indicator light

---

You can control the incoming call indicator light (available on the **M3904**). After you select **Call indicator light** from the **Options List** menu;



From the **Indicator** screen, press the **On** Key to turn on Call indicator light, press the **Off** Key to turn off Call indicator light.

Press the **Done** Key to save changes. Press the **Quit** Key or **Options** Key to exit.

## Set On hook default path

The **On hook default path** option (available on the **M3903** and **M3904**) automatically opens the voice path on either the Headset or on Handsfree when you press a Line (DN) Key. After you select **On hook default path** from the **Options List** menu;



Handsfree selected

or

Headset selected

From the **On hook path** menu, use the **Navigation** Keys to highlight and select either:

Handsfree selected

or

Headset selected

Press the **Done** Key to save selection. Press the **Quit** Key or **Options** Key to exit.

Amplified headsets are compatible with your M3900 Series Meridian Digital Telephone. The amplified headset is an option for noisy environments. An amplified headset should be connected to the handset jack. The Headset Key is not able to control a headset that is connected to the handset jack. In this configuration, do not select Headset as the On hook default path.

For an amplified headset, adjust the volume using the **Volume Control Bar** on your telephone before adjusting the volume on your headset amplifier. To minimize distortion, the volume setting on the amplifier should be higher than the volume setting on the telephone.

Unamplified headsets are compatible with the **M3903** and **M3904**. An unamplified headset should be plugged into the headset jack. With Headset selected as the On hook default path, you can make calls or answer incoming calls by pressing a **DN** Key.

For an unamplified headset, access Volume Adjustment in the Options List to adjust the headset volume and sidetone (**M3904**) that work best with the headset you are using. You may also use the **Volume Control Bar** to adjust the headset volume while you are on a call.

Refer to your distributor for the latest product bulletin from Nortel Networks for recommended headset types for the M3900 Series telephones.

## Display diagnostics

---

The **Display diagnostics** option tests the functionality of your telephone's display screen and indicator lights. This option also provides information on the firmware currently in use on your M3900 series telephone. After you select **Display diagnostics** from the **Options List** menu;



Use the up or down **Navigation** Keys to scroll through the list and view the changing display screens.

Press the **Done** Key to return to the **Options List** menu. Press the **Quit** Key or **Options** Key to exit.

## Activate Group Listening

---

The **Group Listening** feature allows you to talk on the handset to one party while other people listen to the conversation on your telephone's speaker. The network administrator must enable this feature. After you select **Group listening** from the **Options List** menu;



From the **Group listening** screen, press the **On** Key to turn on Group listening, press the **Off** Key to turn off Group listening.

Press the **Done** Key to save changes. Press the **Quit** Key or **Options** Key to exit.

**Note 1:** The Group listening selection will not appear in the Options List menu of your telephone unless this feature has been enabled by your network administrator.

**Note 2:** You must let the caller know when others are listening to the conversation. This feature does not provide a tone to inform the party on the other end of the call that the conversation is being monitored.

## Call Log/Personal Directory display and controls

The **M3903** has a one line display. When you press the **Call Log** Key, the following screen appears:

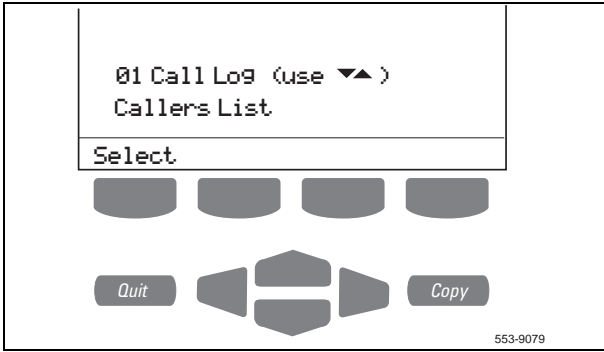

The **M3904** has a three line display. When you press the **Directory/Log** Key, the following screen appears:



### Identify specialized keys

The **Navigation** Keys  enable you to scroll through the features and application functions.

The **Copy** Key  /  copies incoming or outgoing call numbers into your Personal Directory (available on the **M3904**).

The **Quit** Key  ends an active application, which does not affect the status of the calls currently on your telephone.



## Use Directory password protection

You can password protect your Call Log, Redial list, and Personal Directory.

To enable password protection:



or



### Password Administration

Select



Select



On



Enter



1. Press the **Call Log** Key (**M3903**) or the **Directory/Log** Key (**M3904**).
2. From the **Directories** menu, use the **Navigation** Keys to highlight **Password Administration**.
3. Press the **Select** Key.  
The **Password Administration** menu appears with **Password enabled: OFF** highlighted.
4. Press the **Select** Key again to select **Password enabled: OFF**.
5. Press the **On** Key to enable password protection.
6. **Dial** the password.
7. Press the **Enter** Key.
8. **Dial** (enter) the password again to confirm your password.

Enter



9. Press the **Enter** Key.

Press the **Done** Key to save changes. Press the **Quit** Key, **Call Log** Key, or **Directory/Log** Key to exit.

To disable Personal Directory password:



or



1. Press the **Call Log** Key (**M3903**) or the **Directory/Log** Key (**M3904**).



2. **Dial** the password.

Enter



3. Press the **Enter** Key.



4. Use the **Navigation** Keys to highlight **Password Administration**.

## Password Administration

Select



5. Press the **Select** Key.

The **Password Administration** menu appears with **Password enabled: ON** highlighted.

Select



6. Press the **Select** Key again to select **Password enabled: ON**.

Off



7. Press the **Off** Key to disable password protection.

Press the **Done** Key to save changes. Press the **Quit** Key, **Call Log** Key, or **Directory/Log** Key to exit.

## Manage Call Log

The **Call Log** records the name and number of incoming and outgoing calls and can be password protected on the **M3904**. You can activate Call Log to record all calls, record only the unanswered calls, or record no incoming calls.

The **Callers List** stores incoming calls, and the **Redial List** stores outgoing calls in order of date and time received/made. The oldest call is stored at the top of the list. The newest call is stored at the bottom of the list.

The **M3904** Call log list holds up to 100 entries for incoming calls in the Callers List and 20 entries for outgoing calls in the Redial List. The **M3904** can copy a number from the Callers List or Redial List and store it in the Personal Directory.

The **M3903** Call log list holds up to 10 entries for incoming calls in the Callers List and 5 entries for outgoing calls in the Redial List.

### Access and use the Callers List (M3903)

To access the Callers List using the Call Log Key:



Callers List

Select



New

Old

or



1. Press the **Call Log** Key.
2. Use the **Navigation** Keys to highlight Callers List.
3. Press the **Select** Key.
4. Press the **New** Key to go to the top of the new calls list, or press the **Old** Key to go to the top of the old calls list.

To access the Callers List using a Context Sensitive Soft Key or a Programmable Feature Key:

Callers



Press the **Callers** Key.

If there are new calls, you are presented with the first call in the new calls list. If there are no new calls, you are presented with the first call in the old calls list.

To make a call from the Callers List:



2498

Dial



1. Use the **Navigation** Keys to scroll through the Callers List and highlight the number you want to call.

**Note 1:** If you are calling an external or long distance number, you will need to edit the number to add the access codes required by your system to make an external or long distance call.

**Note 2:** Press the **Pause** Key to insert a 1.5 second pause in the dialing string.

2. Press the **Dial** Key to call the number selected. You leave the Callers List when you make the call.

To exit the Callers List without making a call:

Quit

or

Call Log



Press the **Quit** Key.

or

Press the **Call Log** Key.

## Access and use the Callers List (M3904)

To access the Callers List:

Directory/Log



Call Log (Callers List)

Select



1. Press the **Directory/Log** Key.
2. Use the **Navigation** Keys to highlight Call Log (Callers List).

3. Press the **Select** Key.



To access the Callers List using a Context Sensitive Soft Key or a Programmable Feature Key:

Callers



To make a call from the Callers List:



2498

Dial



To exit the Callers List without making a call:

Quit

or

Directory/Log



4. Press the **New** Key to go to the top of the new calls list, or press the **Old** Key to go to the top of the old calls list.

Press the **Callers** Key.

If there are new calls, you are presented with the first call in the new calls list. If there are no new calls, you are presented with the first call in the old calls list.

1. Use the **Navigation** Keys to scroll through the Callers List and highlight the number you want to call.

**Note 1:** If you are calling an external or long distance number, you will need to edit the number to add the access codes required by your system to make an external or long distance call.

**Note 2:** Press the **Pause** Key to insert a 1.5 second pause in the dialing string.

2. Press the **Dial** Key to call the number selected. You leave the Callers List when you make the call.

Press the **Quit** Key.

or

Press the **Directory/Log** Key.

## Access and use the Redial List (M3903)

To access the Redial List using the Call Log Key:



Redial List

Select



To access the Redial List using a Context Sensitive Soft Key or a Programmable Feature Key:

Redial



To make a call from the Redial List:



2637

Dial



1. Press the **Call Log** Key.
2. Use the **Navigation** Keys to highlight Redial List.
3. Press the **Select** Key.

Press the **Redial** Key.

You are presented with the most recently dialed number.

1. Use the **Navigation** Keys to scroll through the Redial List and highlight the number you want to call.

**Note:** If you are calling an external or long distance number, be sure that the appropriate access codes are included.

2. Press the **Dial** Key.  
Your call is automatically dialed and you exit the Redial list.

## Access and use the Redial List (M3904)

To access the Redial List using the Directory/Log Key:



Call Log (Redial List)

Select



To access the Redial List using a Context Sensitive Soft Key or a Programmable Feature Key:

Redial



To make a call from the Redial List:



2637

Dial



1. Press the **Directory/Log** Key.
2. Use the **Navigation** Keys to highlight Redial List.
3. Press the **Select** Key.

Press the **Redial** Key.

You are presented with the most recently dialed number.

1. Use the **Navigation** Keys to scroll through the Redial List and highlight the number you want to call.

**Note:** If you are calling an external or long distance number, be sure that the appropriate access codes are included.

2. Press the **Dial** Key.

Your call is automatically dialed and you exit the Redial list.

## Access and use the Personal Directory

The Personal Directory (available on the **M3904**) provides a personalized directory of names and telephone numbers. The Personal Directory allows you to add, delete, search, and edit entries and can be password protected. The Personal Directory holds up to 100 entries (an entry is one name and one telephone number). You can add a directory entry by copying the entry from your Callers List or Redial List. You can also add entries with the "Add New" Key or by using the Personal Directory PC Utility application. The Personal Directory PC Utility uses an accessory cartridge to connect your PC and your **M3904** telephone. You can create a directory on your Personal Computer and transfer it to your **M3904** telephone.

### Access the Personal Directory

---



Select



1. Press the **Directory/Log** Key.
2. Press the **Select** Key in the **Directories** menu to select Personal Directory.

**Note:** When you press the **Directory/Log** Key, your Personal Directory is automatically selected. At this point, you may begin searching the directory using the telephone's dial pad. See "Search for an entry" on page 48.

### Add a Personal Directory entry

---

After accessing your Personal Directory:

AddNew



1. Press the **Add New** Key.
2. **Dial** the new name.



**Example:**  
To enter the name and telephone number for **Chris**:



Next



Done



1. **Dial** the name using the key pad.

**Note:** Press the **Up Navigation** Key to access special characters you may want to include in the name. Use the **Navigation** Keys to locate the character you want to include. Press the **Select** Key to choose the highlighted character. Press the **Return** Key to return to label entry without selecting a special character.

2. Press the dial pad **key** with the desired letter repeatedly until that letter appears on the display.
3. Press the right **Navigation** key to go to the next letter.

**Note:** The cursor automatically advances to the next position, if a different-from-last key is pressed, or after a short pause.

4. Press the **Next** Key.
5. Use the **dial pad** to enter the telephone number associated with the name entered above.

**Note 1:** The number may contain up to 31 digits.

**Note 2:** Press the **Pause** Key to insert a 1.5 second pause in the dialing string.

**Note 3:** If you are adding an external or long distance number, be sure to include the access codes required by your system to make an external or long distance call.

6. When you have finished entering all of the digits, press the **Done** Key to save the changes.

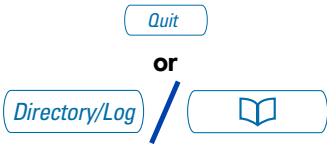

7. Press the **Quit** Key or the **Directory/Log** Key to exit.

## Add an incoming call

---



Dirctry



Next



or

Clear



Next



Done



1. Press the **Copy** Key. The displays shows the message **COPY to**.
2. Press the **Directory** Key when the prompt asks **COPY to?**.
3. Press **Next** to copy the incoming call without editing the name. Edit the number, if required (see note for step 4), and go to step 5.  
**or**  
Press **Clear** to make changes to the name before saving. Add the name using the **dial pad**, **Delete**, and **Case** Keys as needed.
4. Press the **Next** Key. Make changes to the telephone number, if required.

**Note 1:** The number may contain up to 31 digits.

**Note 2:** Press the **Pause** Key to insert a 1.5 second pause in the dialing string.

**Note 3:** If you are adding an external or long distance number, be sure to include the access codes required by your system to make an external or long distance call.

5. Press the **Done** Key to save the entry in your directory.

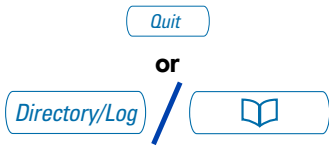

6. Press the **Quit** Key or the **Directory/Log** Key to exit.

**Note:** You can edit the name or number before or after you save to the directory.

## Delete or edit a Personal Directory entry

To delete a Personal Directory entry:



1. Use the **Navigation** Keys to highlight the entry you want to edit or delete.
2. Press the **Delete** Key to delete the currently highlighted entry in your Personal Directory.
3. Press the **Yes** Key to confirm the deletion.

To edit a Personal Directory entry:



1. Press the **Edit** Key to change the telephone number or name.
2. Use the **Navigation** Keys to highlight the character you want to change.
3. Use the **dial pad** to enter the desired changes. Refer to "Add a Personal Directory entry" on page 42 for an example of how to use the dial pad to enter names.
4. Press the **Next** Key. Edit the number if necessary.
5. Press the **Done** Key to save the changes.
6. Press the **Quit** Key or the **Directory/Log** Key to exit.

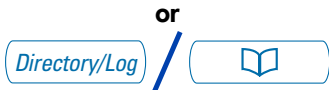

## Delete your Personal Directory

---

To delete your Personal Directory:

DelList



Yes



or

No



Quit



or

Directory/Log



1. Press the **Delete List** Key. The message Delete all entries? appears.
2. Press the **Yes** Key if you want to delete all the entries in your Personal Directory.  
  
**or**  
Press the **No** Key if you want to return to the top of the Personal Directory with no changes made.
3. Press the **Quit** Key or the **Directory/Log** Key to exit.

## Use the Personal Directory to make a call

---

To use the Personal Directory to make a call:



Purchasing

Dial



1. Use the up or down **Navigation** Keys to highlight the desired name or number.  
  
**Note:** If you are dialing an external or long distance number, be sure that your directory entry includes the access codes required by your system to make an external or long distance call.
2. Press the **Dial** Key.

**Note:** If your primary DN is busy, the following message will be displayed Unable to Dial - Busy Primary Line. Press the **OK** Key to clear the message. Select an available **DN** Key, and press the **Dial** Key again.

## Use Card View

---

The **Card View** feature provides additional information about the Personal Directory entry.

To look at the Card View:



1. Highlight the **name**.
2. Press the right **Navigation** Key.

To dial from Card View:



1. Use the **Navigation** Keys to show the name and number of the currently selected entry in the Card View.

**Note:** If you are dialing an external or long distance number, be sure that your directory entry includes the access codes required by your system to make an external or long distance call.

Dial



2. Press the **Dial** Key to place the call.

**Note:** If your primary DN is busy, the following message will be displayed **Unable to Dial - Busy Primary Line**. Press the **OK** Key to clear the message. Select an available **DN** Key, and press the **Dial** Key again.

To exit Card View:



Press the left **Navigation** Key to leave the Card View and return to the selected name.

## Search for an entry

---

You can search for a particular entry in your Personal Directory.

To search for an entry:



Personal Directory

Select



1. Use the **Navigation** Keys to scroll through the **Directories** menu and highlight Personal Directory.
2. Press the **Select** Key.
3. Use the **dial pad** to enter the first letter of the name you are seeking. For example, press **2** twice to go to the first entry that begins with the letter "B".

**Note:** To further refine your search, wait a couple of seconds and use the **dial pad** to enter the second letter of the name you are seeking. You may enter up to the first three letters in the name using this method.

## Copy a number from the Redial List

---

You can copy a number from the Redial List to the Personal Directory.

To copy a number from the Redial List:



2498



Dirctry



1. Use the **Navigation** Keys to highlight the name or number in your Redial List that you want to copy to your Personal Directory.
2. Press the **Copy** Key.  
The display shows COPY to?.
3. Press the **Directory** Key.

Next



or

Clear



Next



Done



4. Press **Next** to copy the incoming call without editing the name. Edit the number, if required (see notes for step 5), and go to step 6.

or

Press **Clear** to make changes to the name before saving. Add the name using the **dial pad**, **Delete**, and **Case** Keys as needed.

5. Press the **Next** Key. Make changes to the telephone number, if required.

**Note 1:** The number may contain up to 31 digits.

**Note 2:** Press the **Pause** Key to insert a 1.5 second pause in the dialing string.

**Note 3:** If you are copying an external or long distance number, be sure that your directory entry includes the access codes required by your system to make an external or long distance call.

6. Press the **Done** Key. The entry is saved to your Personal Directory and you are returned to the Redial List.

## Set-to-Set Messaging

With the **Set-to-Set Messaging** application activated (available on the **M3903** and **M3904**), an internal caller using an **M3903** or **M3904** telephone receives a quick visual message, which you have selected, whenever they dial your telephone number. The length of your message is limited to 24 characters. The message is entered through the dial pad keys using a process similar to the one used for entering names in the **M3904**'s Personal Directory. Only one message can be stored in your telephone's memory.

You can check your Call Log to determine whether or not a caller was sent the set-to-set message. A \* (**M3903**) or (⇆) (**M3904**) will appear beside the call log entry of the callers who saw your message. **Note:** This feature is not available on the Meridian SL-100.

### To access Set-to-Set Messaging:



Set to Set Messaging

Select



1. Press the **Applications** Key.
2. From the **Applications** menu, use the **Navigation** Keys to highlight **Set to Set Messaging**.
3. Press the **Select** Key. The **Set-Set Message** screen appears indicating the status of the feature (on or off) and whether or not a message is stored (defined) in memory.

**Note:** On the M3904, if you have activated password protection on your Directory/Log, you will need to enter your password to continue.

### To edit the currently stored message, or to create a new message:

Edit



1. Press the **Edit** Key.





- From the **Edit Mode** screen, use the **dial pad** to enter a text message. Press the **Delete** Key to delete a character. Press the **Case** Key to toggle between upper and lower case characters. Press the **Cancel** Key to exit the screen without saving changes.

**Note 1:** Please refer to “Add a Personal Directory entry” on page 42 for detailed instructions on using your telephone’s dial pad to enter text.

**Note 2:** While in the **Edit Mode** screen, Press the **Up Navigation** Key to access special characters you may want to include in the name. Use the **Navigation** Keys to locate the character you want to include. Press the **Select** Key to choose the highlighted character. Press the **Return** Key to return to label entry without selecting a special character.

Done



To select a message provided by your network administrator:



Select



To customize a message provided by your network administrator:



Edit



- Press the **Done** Key.

Your message is saved and you return to the **Set-Set Msg** Screen.

- From the **Set-Set Msg** screen, use the **Navigation** Keys to scroll through the list of available messages.
  - Press the **Select** Key to choose the currently displayed message.
- From the **Set-Set Msg** screen, use the **Navigation** Keys to scroll through the list of available messages.
  - Press the **Edit** Key to choose the currently displayed message.



3. From the **Edit Mode** screen, use the **dial pad** to customize the message. Press the **Delete** Key to delete a character. Press the **Case** Key to toggle between upper and lower case characters. Press the **Cancel** Key to exit the screen without saving changes.

**Note 1:** Please refer to “Add a Personal Directory entry” on page 42 for detailed instructions on using your telephone’s dial pad to enter text.

**Note 2:** While in the **Edit Mode** screen, press the **Up Navigation** Key to access special characters you may want to include in your message. Use the **Navigation** Keys to locate the character. Press the **Select** Key to choose the highlighted character. Press the **Return** Key to return to message entry without selecting a special character.

Done



4. Press the **Done** Key.

Your message is saved and you return to the **Set-Set Msg** Screen.

**Note:** If you scroll to a different message in the **Set-Set Msg** screen, and press the **Select** Key, your changes are erased.

To activate or deactivate Set-to-Set Messaging and exit the application:

On



Off



1. Press the **On** Key/**Off** Key to toggle the Set-to-Set Messaging status between On and Off.

**Note 1:** If messages have not been provided by your network administrator and a message has not been defined, the **On** and **Off** Keys will not appear. Use the **Edit** Key to enter a message before activating Set-to-Set Messaging.

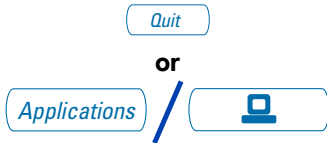

**Note 2:** If messages have been provided by your network administrator, up and down arrows appear on the right side of the display. The **On** and **Off** Keys appear for the most recently selected message.

2. Press the **Quit** Key or the **Applications** Key to exit the **Set-to-Set Messaging** application.

**Note:** If you press the **Quit** Key or the **Applications** Key before you press the **Done** Key, you exit the application without saving your changes.

## Corporate Directory

The **Corporate Directory** application (available on the **M3903** and **M3904**) allows you to search by entering the characters in the name of the person you are calling, beginning with the last name. Once you have located the name and number of the person, you may use the dial soft key to call the number. On the **M3904**, you may copy an entry from the Corporate Directory and paste it into your telephone's Personal Directory for quick access.

**To use the Corporate Directory application:**



1. Press the **Applications** Key.

**Note:** If, when you press the **Applications** Key, Corporate Directory is highlighted, you may proceed directly to step 4.

2. From the **Applications** menu, use the **Navigation** Keys to highlight Corporate Directory.



Corporate Directory

Select



3. Press the **Select** Key. The **Cor Dir Find** screen appears.
4. Use the **dial pad** to enter the name of the person you want to call. Enter the last name first. Separate the last name and first name with a comma.



**Note 1:** The comma is the first character on the  Key on your dial pad.

**Note 2:** You do not need to enter the entire name. When the **Done** Key is pressed, the application will highlight the first directory entry that matches the text that you entered.

5. Press the **Done** Key. The application highlights the first directory entry that matches the text you entered in step 4. If there is no match, the screen displays *No matches found for . . .* (the text that you entered).
6. Use the **Navigation** Keys to scroll through the directory.

**Note:** The entire directory is available. The “find” process determines which directory entry to select as your starting point.

7. If desired, use the right **Navigation** Key to move from “list” view to “card” view. In card view, the telephone and department numbers for the entry are viewable. Use the left **Navigation** Key to return to list view.

**Note:** While you are in card view, you may use the up or down **Navigation** Keys to scroll through directory entries.

8. Press the **Dial** Key to call the person whose name is highlighted.

**Note:** On the Meridian SL-100, if your primary **DN** Key is busy, select an available **DN** Key after pressing the **Dial** Key.

To find another directory listing or to refine your current directory search:



Press the **NewFind** Key to begin a new search, or press the **Resume** Key to enter additional characters so that you may narrow your search.

To exit the Corporate Directory application:

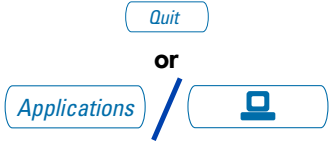

Press the **Quit** Key or the **Applications** Key.

To copy an entry from the Corporate Directory to your telephone's Personal Directory:



1. With the entry selected in the Corporate Directory, press the **Copy** Key.
2. In the **Copy to** screen, press the **Directory** Key to copy the name and telephone number to your Personal Directory. After you complete editing and entering the name and telephone number, you are returned to the Corporate Directory.

To transfer a call to a number in the Corporate Directory:

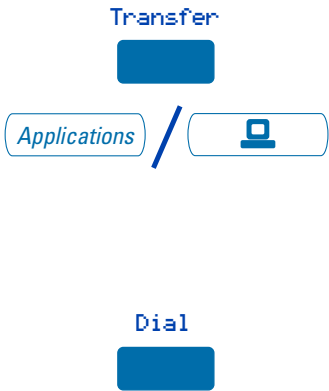

1. Before accessing the Corporate Directory, press the **Transfer** Key.
2. Press the **Applications** Key.  
Follow the steps outlined in "To use the Corporate Directory application:" on page 53 to find the person to whom you want to transfer the call.
3. Press the **Dial** Key to transfer the call to the person whose name is highlighted.

## Virtual Office

The **Virtual Office** feature (available on the **M3903** and **M3904**) allows you to log into a specially designated **M3903** or **M3904** telephone. When you log into the telephone your individual configuration is downloaded to the telephone for line (DN) and feature access. Virtual Office is ideal for use on a telephone which may be assigned to different users depending on the hour-of-the-day or the day-of-the-week.

To logon to the **Virtual Office** telephone:



1. Lift the **handset**.
2. **Dial** the **Virtual office Terminal Log on (VTLN)** FFC on the Meridian 1 or the **Virtual Office Worker IN (VOWIN)** FAC on the Meridian SL-100.
3. On the Meridian 1, from the **VTN Login** screen, **Enter** your password using the telephone's dial pad.

On the Meridian SL-100, you will receive dial tone. **Enter** the **VOW** authorization code, if required on your system; then, after you receive dial tone, **Enter** your personal authorization code.

**Note:** If you make a mistake while entering a code or number on the Meridian SL-100, press the  Key and re-enter the code.

4. On the Meridian 1 you will be prompted to **Enter** your User ID. Use the dial pad to **Enter** the primary line (DN) assigned to your Virtual Office telephone.

On the Meridian SL-100, you will receive dial tone. Use the dial pad to **Enter** the primary line (DN) for your telephone; then, after you receive dial tone, **Enter** your passcode.

**Note 1:** If your Virtual Office telephone is configured as an M3903, you may only log on to an M3903. If your Virtual Office telephone is configured as an M3904, you may only log on to an M3904.

**Note 2:** If two or more users are attempting to log on at the same moment, the system processes the log on information for the first user. The other users will receive a *System busy, try later.* message. Wait a moment and try to log on again.

To logoff the Virtual Office telephone:



or

VTLF FFC



1. Lift the **handset**.
2. **Dial** the Virtual office Terminal Log off (VTLF) FFC on the Meridian 1 or the Virtual Office Worker OUT (VOWOUT) FAC on the Meridian SL-100.

or

If available, **Press** the autodial key which has been configured to dial the **VTLF** FFC.

**Note 1:** You can not be logged on to more than one Virtual Office telephone at any time.

**Note 2:** Your network administrator determines whether or not your Callers List and Redial List are erased when you log off the Virtual Office telephone. This automatic erase feature is not available on the Meridian SL-100.

## Secure your telephone

You can lock your telephone with a password to prevent unauthorized use of your telephone. **Note:** This feature is not available on the Meridian SL-100.

### To lock your telephone:



1. Lift the **handset**.
2. **Dial** the Lock Flexible Feature Code (FFC) and your Electronic Lock Password.

**Note:** If you perform this operation from someone else's telephone, dial your line (DN).

3. Press the **Goodbye** Key.

### To unlock your telephone:



1. Lift the **handset**.
2. **Dial** the Unlock Flexible Feature Code (FFC) and your Electronic Lock Password.

**Note:** If you perform this operation from someone else's telephone, dial your line (DN).

3. Press the **Goodbye** Key.

### To change your password:



1. Lift the **handset**.
2. **Dial** the Password Change Flexible Feature Code (FFC) and your current password. **Dial** your new password twice (for verification).

3. Press the **Goodbye** Key.





Title to and ownership of Meridian SL-1 software shall at all times remain with Nortel Networks. Meridian SL-1 software shall not be sold outright and the use thereof by the customer shall be subject to the parties entering into software agreements as specified by Nortel Networks.

Information contained in this document is subject to change. Nortel Networks reserves the right, without notice, to make changes in equipment design or program components as progress in engineering, manufacturing or technology may warrant.

Reordering number: NT2F81EA Ao859354  
(c/o 5 each per package P0942351)

Internal Manufacturing part number:

P0942351

Issue 1.00

January 2002

Printed in Canada

[www.nortelnetworks.com](http://www.nortelnetworks.com)

**NORTEL**  
**NETWORKS**